

DRAWING (mm)

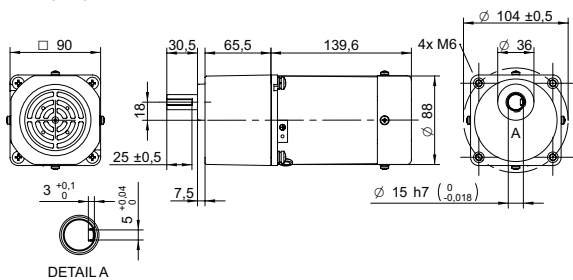

AC induction motor and gearbox also sold separately.

PHOTO

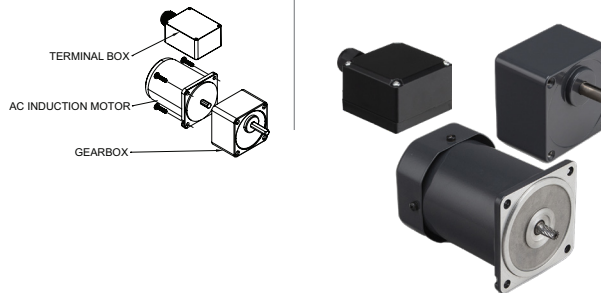

MODEL NO. DESIGNATION

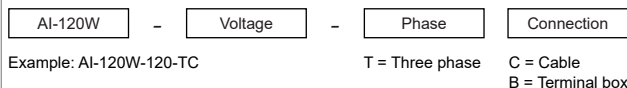

ACCESSORIES¹



C = customizations are offered on demand even for smaller quantities. Typical customizations are indicated with a green dot at column end. Please contact us for any customization request.

GEAR MOTOR DATA C

Gear ratio		3	3.6	5	6	7.5	9	10	12.5	15	18	20	25	30	36	40	50	60	75	90	100	120	150	180	200
Nominal torque	Nm	1.8	2.2	3.0	3.6	4.6	5.5	6.1	7.6	9.1	11	11	14	16	20 ²	20 ²	20 ²	20 ²	20 ²	20 ²	20 ²	20 ²	20 ²	20 ²	20 ²
Nominal speed	rpm	520	430	310	260	210	170	160	120	100	86	78	62	52	43	39	31	26	21	17	16	13	10	8,6	7,8
Nominal power	W	99	99	99	99	99	99	99	99	99	99	89	89	89	90	81	65	54	43	36	32	27	22	18	16
Gearb. nom. torq. ³	Nm	20	20	20	20	20	20	20	20	20	20	20	20	20	20	20	20	20	20	20	20	20	20	20	20
Gearbox efficiency	%	81	81	81	81	81	81	81	81	81	81	73	73	73	73	73	73	66	66	66	66	66	66	66	66
Radial load ⁴	N	500	500	500	500	500	500	600	600	600	600	700	700	700	700	700	700	700	700	700	700	700	700	700	700
Direction of rot.		CW	CW	CW	CW	CW	CW	CCW	CCW	CCW	CCW	CW	CW	CW	CW	CW	CW	CW	CW	CCW	CCW	CCW	CCW	CCW	CCW
Weight	kg	4.9	4.9	4.9	4.9	4.9	4.9	4.9	4.9	4.9	4.9	4.9	4.9	4.9	4.9	4.9	4.9	4.9	4.9	4.9	4.9	4.9	4.9	4.9	4.9

OTHER GEAR MOTOR DATA C

Service life	h	10000
Performance tolerances		± 15
Operating temperature	°C	-10 to 40
IP rating ⁵		IP20 IP54
Manufacturing standard		ISO 9001
CE label UL label		No No

AC INDUCTION MOTOR DATA C

Nominal voltage	V	220
No. of phases		3
Frequency	Hz	60
No. of poles		4
Nominal speed	rpm	1550
Nominal torque	mNm	750
Nominal current	A	0.6
Nominal power	W	120
Stall torque	mNm	1600
Insulation class		B
Motor cable		AWG18
Motor cable length	mm	300
Capacitor included in delivery	µF	-
Insulation resistance	MΩ	100
Dielectric strength	kV	1.5
Max. winding temperature	°C	80
Weight	kg	3.4

GEAR MOTOR RANGE AI-SERIES¹

Nominal voltage	V	See separate datasheet
Nominal power	W	See separate datasheet
Dimension	mm	See separate datasheet

NOTES

- See page 2 of this catalog.
- Gear motor torque limited by gearbox.
- Gearbox nominal torque.
- 20 mm from shaft.
- IP20 without terminal box, IP54 with terminal box.
- Cables/wires for connecting terminal box not included with AC induction motor.
- Visit www.transmotec.com to view datasheets.

WIRING DIAGRAM AC INDUCTION MOTOR⁶

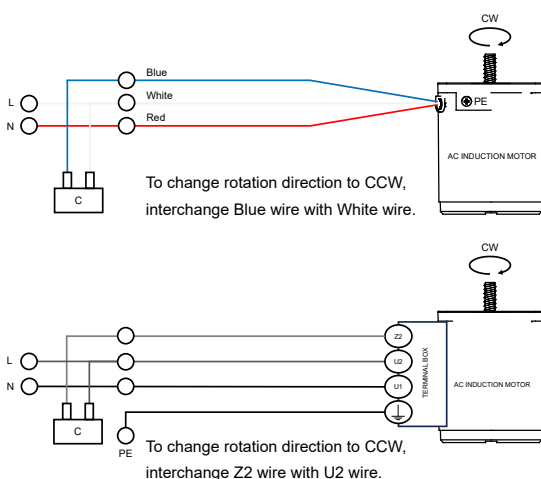

DECIMAL GEARBOX¹

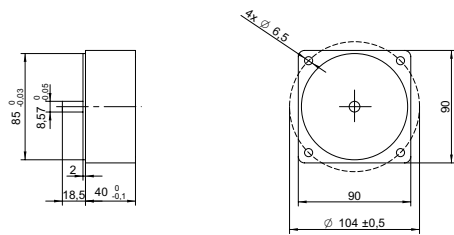

DECIMAL GEARBOX DATA

Model designation	S90A-Y010	
Gear ratio	10:1	
Nominal torque	Nm	10
Description	Connected between AC motor and existing gearbox to decrease the speed further than the gear ratio listed in the table.	

OUTPUT SHAFT D-CUT

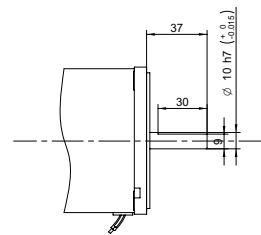

DECIMAL GEARBOX DATA

Model designation Contact us for more information.

POWER CABLE

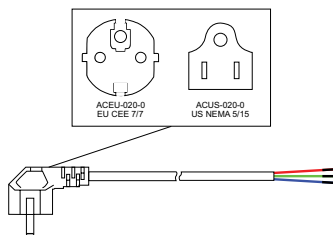

POWER CABLE DATA

Model designation	ACEU-020-0 ACUS-020-0	
Standard	EU CEE 7/7 US NEMA 5/15	
Cable length	m ft	2 8

MOUNTING BRACKET

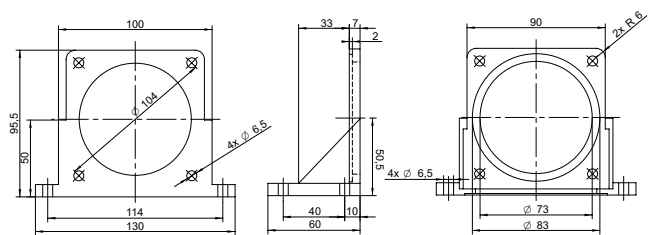

MOUNTING BRACKET DATA

Model designation	AMB-090	
Dimensions	mm	90x90

TERMINAL BOX

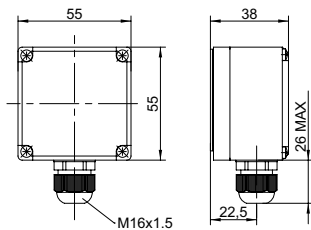

TERMINAL BOX DATA

Model designation See model no. designation to order correct part number.

GEARBOX FLANGE MOUNTING

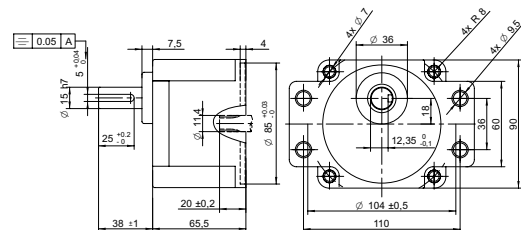

GEARBOX FLANGE MOUNTING DATA

Model designation Contact us for more information.

NOTES

1. Visit www.transmotec.com to view datasheets.